

Fiber
Lo=1421.35mm

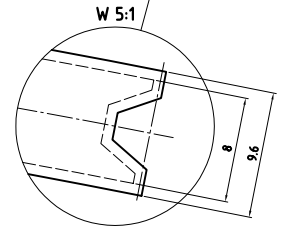

all fibers glued in
with BC 600

Sealed with Dow Corning
Silastic 732 RTV

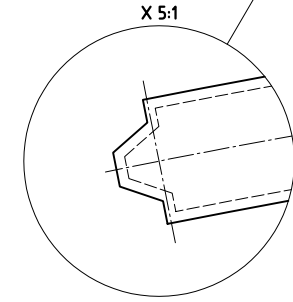
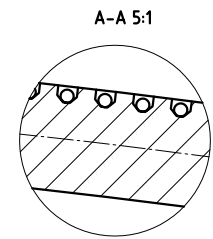
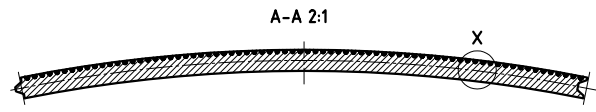
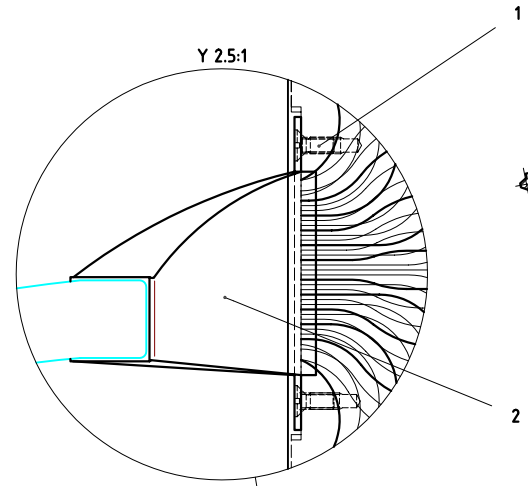
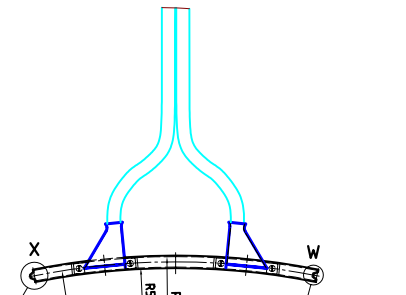
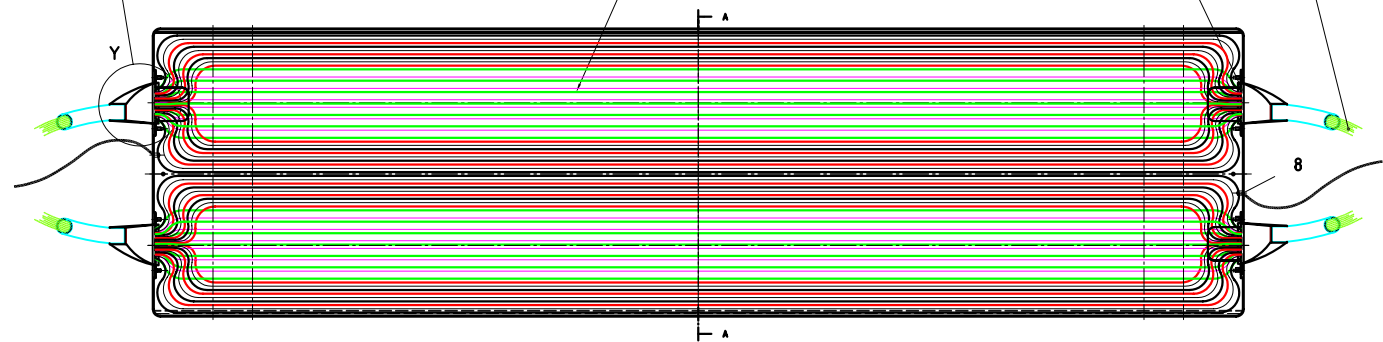

Verwendungsbereich AMS02	Zul. Abw. DIN ISO 8788 mittel	Oberfläche N10	Maßstab 1:2 Werkstoff. Halbsize	Gewicht
			Bearbeitung ACC-Module Anti Coincidence Counter	
			Zeichnungsnummer ams02-1771g	Blatt 1/1 AT/BL
Rev.	Änderung	RevisionName	Physik AC-I	Blatt 1/1 AT/BL